

HL53K

InFloor Duschrinne: Ablaufkörper, waagrecht, DN50

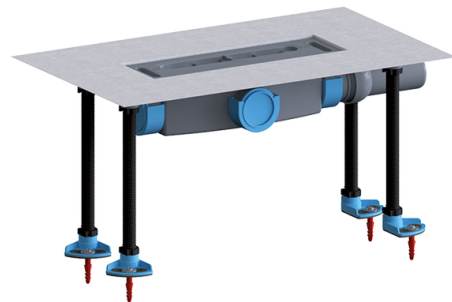

HL53K InFloor Duschrinne: Ablaufkörper, DN50 für die Montage in der Fläche oder an der Wand, mit integrierter Estrichverankerung, Ablaufstutzen links, rechts oder mittig positionierbar, flexibel einsetzbarer Dichtmanschette, höhenverstellbaren Montagefüßen und herausnehmbarem Geruchverschluss.



Techn. Zeichnung

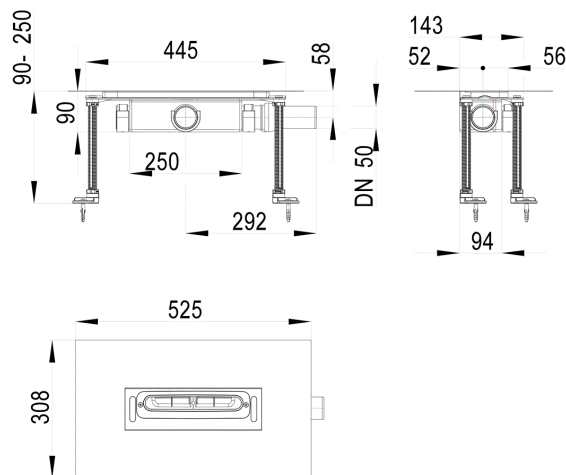

TECHNISCHE DATEN

Material	PP	Einbauhöhe	90-250mm
Dimension	DN50	Aufsatz	
Leistung	0,8l/s	Einlaufrost	
Gewicht	1,336	Belastungsklasse	

HAUPTDATEN**Ersatzteile****HL053.2E**

Abdichtgarnitur mit vlieskaschierter Folie

**HL053.3EN**

Geruchsverschlusseinsatz NEU zu HL53K

**HL053N.1E**

Höhenverstellset zu HL53-Serie, NEU, 4 Stk.Set

Zubehör**HL052M**

Kurzrinne: Aufsatz Edelstahl matt gebürstet 300x50mm

**HL052P**

Kurzrinne: Aufsatz Edelstahl poliert 300x50mm

**HL053M/100**

InFloor Duschrinne: Ablaufschiene Edelstahl matt, 1000mm

**HL053M/110**

InFloor Duschrinne: Ablaufschiene Edelstahl matt, 1100mm

**HL053M/120**

InFloor Duschrinne: Ablaufschiene Edelstahl matt, 1200mm

**HL053M/130**

InFloor Duschrinne: Ablaufschiene Edelstahl matt, 1300mm

**HL053M/140**

InFloor Duschrinne: Ablaufschiene Edelstahl matt, 1400mm

**HL053M/150**

InFloor Duschrinne: Ablaufschiene Edelstahl matt, 1500mm

**HL053M/80**

InFloor Duschrinne: Ablaufschiene Edelstahl matt, 800mm

**HL053M/85**

InFloor Duschrinne: Ablaufschiene Edelstahl matt, 850mm

**HL053M/90**

InFloor Duschrinne: Ablaufschiene Edelstahl matt, 900mm

**HL053M/95**















InFloor Duschrinne: Ablaufschiene Edelstahl matt, 950mm

**HL053P/100**





InFloor Duschrinne: Ablaufschiene Edelstahl poliert, 1000mm

**HL053P/110**

InFloor Duschrinne: Ablaufschiene Edelstahl poliert, 1100mm

-  **HL053P/120**
InFloor Duschrinne: Ablaufschiene Edelstahl poliert, 1200mm
-  **HL053P/130**
InFloor Duschrinne: Ablaufschiene Edelstahl poliert, 1300mm
-  **HL053P/140**
InFloor Duschrinne: Ablaufschiene Edelstahl poliert, 1400mm
-  **HL053P/150**
InFloor Duschrinne: Ablaufschiene Edelstahl poliert, 1500mm
-  **HL053P/80**
InFloor Duschrinne: Ablaufschiene Edelstahl poliert, 800mm
-  **HL053P/85**
InFloor Duschrinne: Ablaufschiene Edelstahl poliert, 850mm
-  **HL053P/90**
InFloor Duschrinne: Ablaufschiene Edelstahl poliert, 900mm
-  **HL053P/95**
InFloor Duschrinne: Ablaufschiene Edelstahl poliert, 950mm
-  **HL053S/100**
InFloor Duschrinne: Ablaufschiene Edelstahl Standard, 1000mm
-  **HL053S/120**
InFloor Duschrinne: Ablaufschiene Edelstahl Standard, 1200mm
-  **HL053S/90**
InFloor Duschrinne: Ablaufschiene Edelstahl Standard, 900mm
-  **HL053WS/100**
"Wall" Standard Duschrinne, mit Wandaufkantung und integriertem Quergefälle, Edelstahl, 1000mm
-  **HL053WS/120**
"Wall" Standard Duschrinne, mit Wandaufkantung und integriertem Quergefälle, Edelstahl, 1200mm
-  **HL053WS/90**
"Wall" Standard Duschrinne, mit Wandaufkantung und integriertem Quergefälle, Edelstahl, 900mm
-  **HL6600**
Schallschutzelement passend zu HL53K

Alternativteile

-  **HL53K.2**
"Wall" Duo Ablaufgehäuse für Duschrinne HL053M(P).2
-  **HL53KC**
InFloor CeraDrain Duschrinne: Ablaufkörper, DN50 waagrecht mit Polymerbetonkragen
-  **HL53KF**
InFloor Duschrinne: Ablaufkörper waagrecht, flach, DN40
-  **HL53KF.2**
"Wall" Duo Ablaufgehäuse flach für Duschrinne HL053M(P).2

**HL53KFC**

InFloor CeraDrain Duschrinne: Ablaufkörper waagrecht, flach, DN40 mit Polymerbetonkragen

**HL53KV**

InFloor Duschrinne: Ablaufkörper senkrecht, DN50