

HL53KF

InFloor Duschrinne: Ablaufkörper waagrecht, flach, DN40



HL53KF InFloor Duschrinne: Ablaufkörper waagrecht flach, DN40 für die Montage in der Fläche oder an der Wand, mit integrierter Estrichverankerung, Ablaufstutzen links, rechts oder mittig positionierbar, flexibel einsetzbarer Dichtmanschette, höhenverstellbaren Montagefüßen und herausnehmbarem Geruchverschluss.



Techn. Zeichnung

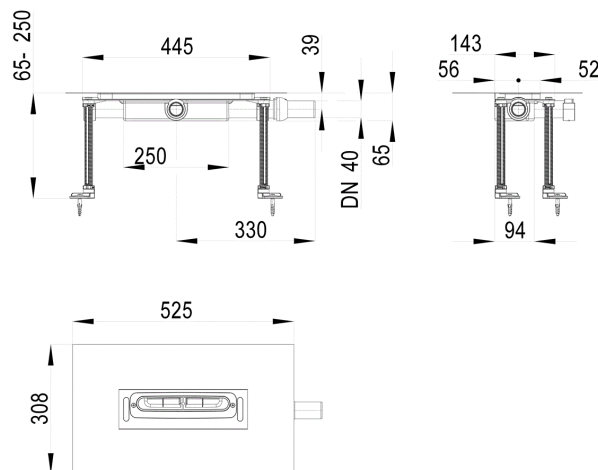

TECHNISCHE DATEN

Material	PP	Einbauhöhe	65-250mm
Dimension	DN40	Aufsatz	
Leistung	0,4l/s	Einlaufrost	
Gewicht	1,25	Belastungsklasse	

HAUPTDATEN**Ersatzteile****HL053.2E**

Abdichtgarnitur mit vlieskaschierter Folie

**HL053N.1E**

Höhenverstellset zu HL53-Serie, NEU, 4 Stk.Set

Zubehör**HL052M**

Kurzrinne: Aufsatz Edelstahl matt gebürstet 300x50mm

**HL052P**

Kurzrinne: Aufsatz Edelstahl poliert 300x50mm

**HL053M/100**

InFloor Duschrinne: Ablaufschiene Edelstahl matt, 1000mm

**HL053M/110**

InFloor Duschrinne: Ablaufschiene Edelstahl matt, 1100mm

**HL053M/120**

InFloor Duschrinne: Ablaufschiene Edelstahl matt, 1200mm

**HL053M/130**

InFloor Duschrinne: Ablaufschiene Edelstahl matt, 1300mm

**HL053M/140**

InFloor Duschrinne: Ablaufschiene Edelstahl matt, 1400mm

**HL053M/150**

InFloor Duschrinne: Ablaufschiene Edelstahl matt, 1500mm

**HL053M/80**

InFloor Duschrinne: Ablaufschiene Edelstahl matt, 800mm

**HL053M/85**

InFloor Duschrinne: Ablaufschiene Edelstahl matt, 850mm

**HL053M/90**

InFloor Duschrinne: Ablaufschiene Edelstahl matt, 900mm

**HL053M/95**

InFloor Duschrinne: Ablaufschiene Edelstahl matt, 950mm

**HL053P/100**















InFloor Duschrinne: Ablaufschiene Edelstahl poliert, 1000mm

**HL053P/110**

InFloor Duschrinne: Ablaufschiene Edelstahl poliert, 1100mm

**HL053P/120**

InFloor Duschrinne: Ablaufschiene Edelstahl poliert, 1200mm

-  **HL053P/130**
InFloor Duschrinne: Ablaufschiene Edelstahl poliert, 1300mm
-  **HL053P/140**
InFloor Duschrinne: Ablaufschiene Edelstahl poliert, 1400mm
-  **HL053P/150**
InFloor Duschrinne: Ablaufschiene Edelstahl poliert, 1500mm
-  **HL053P/80**
InFloor Duschrinne: Ablaufschiene Edelstahl poliert, 800mm
-  **HL053P/85**
InFloor Duschrinne: Ablaufschiene Edelstahl poliert, 850mm
-  **HL053P/90**
InFloor Duschrinne: Ablaufschiene Edelstahl poliert, 900mm
-  **HL053P/95**
InFloor Duschrinne: Ablaufschiene Edelstahl poliert, 950mm
-  **HL053S/100**
InFloor Duschrinne: Ablaufschiene Edelstahl Standard, 1000mm
-  **HL053S/120**
InFloor Duschrinne: Ablaufschiene Edelstahl Standard, 1200mm
-  **HL053S/90**
InFloor Duschrinne: Ablaufschiene Edelstahl Standard, 900mm
-  **HL053WS/100**
"Wall" Standard Duschrinne, mit Wandaufkantung und integriertem Quergefälle, Edelstahl, 1000mm
-  **HL053WS/120**
"Wall" Standard Duschrinne, mit Wandaufkantung und integriertem Quergefälle, Edelstahl, 1200mm
-  **HL053WS/90**
"Wall" Standard Duschrinne, mit Wandaufkantung und integriertem Quergefälle, Edelstahl, 900mm
-  **HL6700**
Schallschutzelement passend zu HL53KF