

HL15-5/4

Ablaufventil 5/4" mit Anschlussgewinde 6/4"



HL15-5/4 Ablaufventil mit Ventilteller 5/4",
Anschlussgewinde 6/4"



Techn. Zeichnung

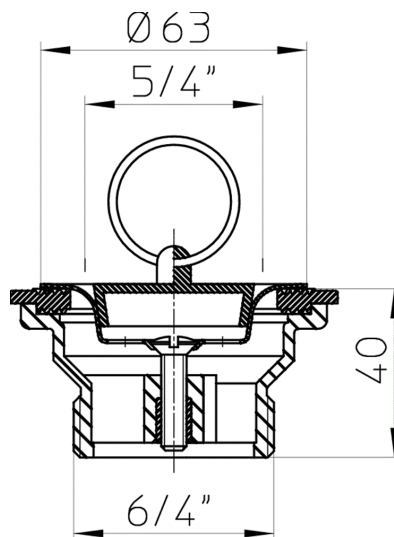

TECHNISCHE DATEN

Material	PP	Einbauhöhe
Dimension	5/4" x 6/4"	Aufsatz
Leistung		Einlaufrost
Gewicht	0,08	Belastungsklasse

EAN

9003076101559

Zulauf

Normen

HAUPTDATEN

Ersatzteile



HL01039D

Ventilteller 5/4"



HL01042D

Ventilschraube M6x25



HL01043D

Ventilstopfen 5/4" mit Ring



HL024.5E

Schlüsselring



HL01053D

Ventildichtung 78x49mm



HL015.1E

Ventilgehäuse